

# SX-2000WG

## Setup Guide

English

silex  
technology



Thank you for purchasing the USB device server, SX-2000WG (this product). This setup guide, "SX-2000WG Setup Guide", provides information on how to configure and use this product in a network environment. Before setup, please read carefully the "Safety instructions" in the online manual included in the CD-ROM to properly configure this product.

Safety instructions are noted in the **Readme** file on the **Device Sever Setup CD**. Be sure to read them before using this product.

### - Safety instructions regarding the radio waves

Please note the following instructions:

- Do not use this product near medical devices such as a heart pacemaker. The radio wave generated by this product may interfere with the operation of these devices and may threaten one's life.
- Do not use this product near microwave ovens. The radio wave used by microwave ovens may cause interference to this product.

(De) Auf der CD-ROM befindet sich ein deutschsprachiges Setup-Handbuch im PDF-Format. Zum Anzeigen der PDF-Datei unter Windows benötigen Sie den Acrobat Reader.

(Fr) Un guide d'installation en français au format PDF est inclus dans le CD-ROM. Acrobat Reader est nécessaire pour lire les fichiers PDF dans un environnement Windows.

(It) Una Guida alla configurazione in italiano è inclusa nel CD-ROM come file PDF. Per visualizzare il file PDF in ambiente Windows è necessario Acrobat Reader.

(Es) En el CD-ROM se incluye una Guía de instalación en español como archivo PDF. Se necesita Acrobat Reader para ver el archivo PDF en un entorno Windows.

(Pt) Um Guia de Configuração em português é fornecido no CD-ROM no formato de arquivo PDF. É necessário ter o Acrobat Reader para visualizar o arquivo PDF em um ambiente Windows.

## Contents

- SX-2000WG
- Warranty Booklet
- Rubber Feet
- Stand
- Power Supply
- Setup Guide
- SX Virtual Link User's Guide
- CD-ROM(Device Server Setup CD)

\* When the product is placed in the horizontal (side) position, please use the rubber feet provided to prevent the unit from sliding. Place one on each corner.

## Name of Parts

FRONT SIDE

BACK SIDE

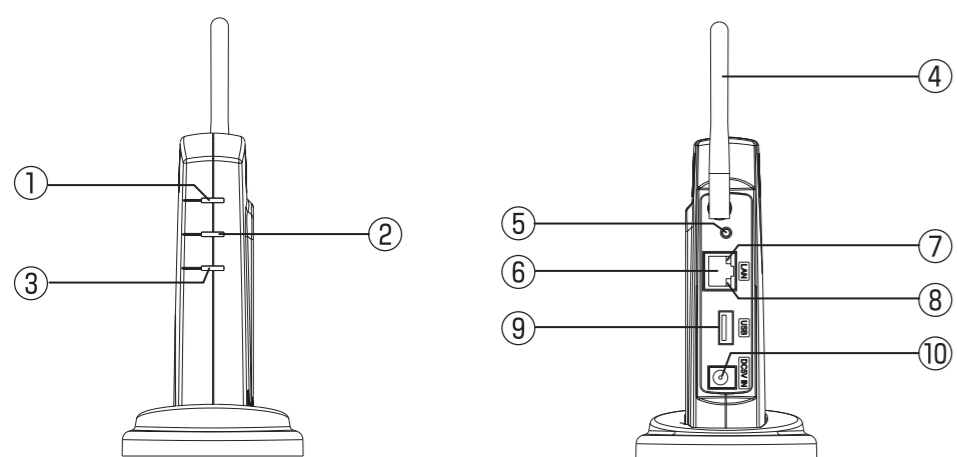

- ① Wireless LED
- ② Status LED
- ③ Link LED
- ④ Wireless LAN antenna
- ⑤ Push Switch
- ⑥ Network Port
- ⑦ Status LED
- ⑧ Link LED
- ⑨ USB Port
- ⑩ AC Connector

## Introduction

### How to connect this product

This product has 4 methods of initial configuration as listed below:

- **Configure through a wired LAN (Recommended)**  
This product is connected to the network using a network cable and configured from the PC.
- **Configure through a wireless LAN**  
The network settings are configured to this product by establishing a wireless connection between a PC and this product in AdHoc mode. To communicate with this product in AdHoc mode, the wireless setting on the PC must be the same as this product.
- **Configure using USB memory**  
The network settings are configured to this product by connecting USB memory in which the configuration information is saved. To write configuration data into the USB memory, use the configuration utility included in the bundled CD-ROM.
- **Configure using Windows Connect Now**  
This product supports "Windows Connect Now", which is one of the functions installed in Windows XP SP2. Windows Connect Now allows connecting this product to a wireless LAN by utilizing a wireless PC (Windows XP SP2) and USB memory.

This Setup Guide describes how to configure this product using a wired Ethernet cable connection, which corresponds to "Configure through a wired LAN" described in the left hand column. For other configuration methods, please refer to the on-line manual on the CD-ROM.

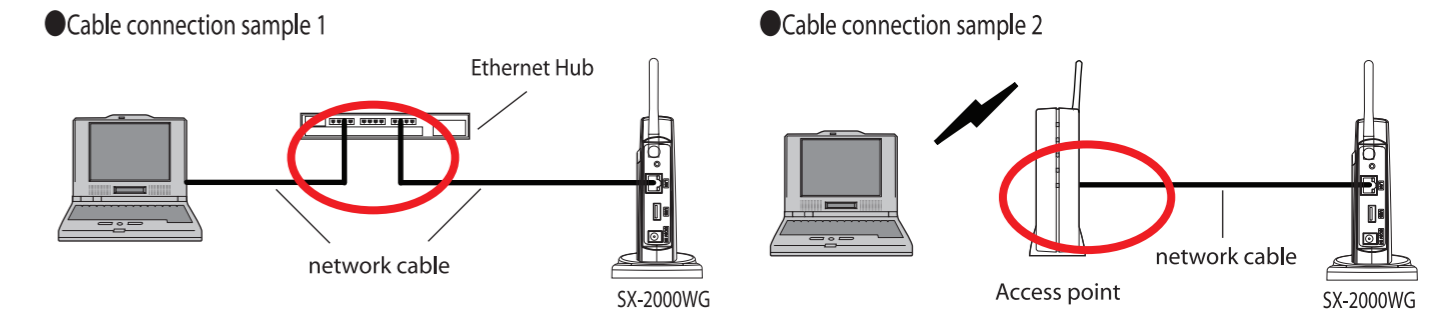

## Step1 : Connect this product to the network

\* If this product has been used in another network, reset it to factory default prior to setup.

### The following items are necessary for the setup.



1.

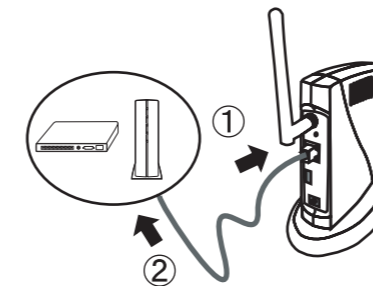

Connect a network cable to this product. Connect the other end of the network cable to one of the following devices which has already been connected to the network.

- Access point
- Broadband router
- Ethernet hub

\* Use a crossover cable when connecting this product directly to the PC.

2.

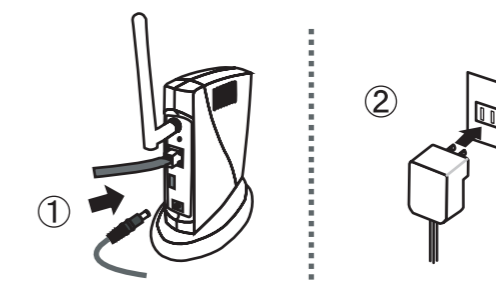

Connect the power supply to this product, and then insert the AC Plug into the electric outlet.

\* Always use the AC adapter bundled with this product.

3.

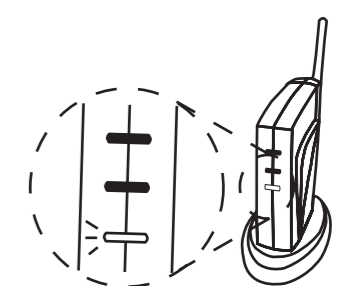

Verify the Link LED (Green) turns on and the Wireless LED (Green) turns off.

## Step2 Initial configuration of this product

Step 2 explains the initial configuration process when this product is connected to the wired LAN via a network cable. You can use this product through a wired or wireless LAN after the configuration is completed

### Windows section

\* Before proceeding to step3, please temporarily disable the firewall function of the PC to be used for the configuration. Some of the procedure to disable the firewall is provided in FAQ on our homepage.

- Standard Windows XP firewall
- Commercial security software's firewall function

1. Please insert the **Device Server Setup CD** into your Windows PC.

2.

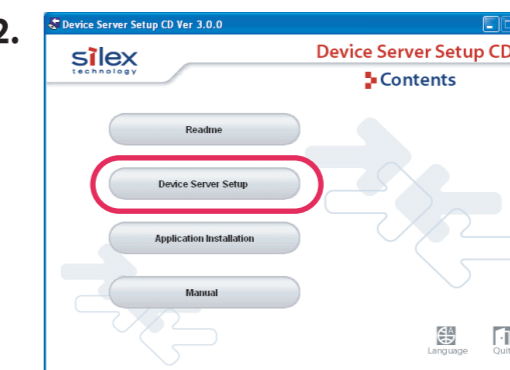

Please select **Device Server Setup** from the menu.

\* If the screen does not appear automatically, open My Computer, select the CD-ROM drive and execute **Autorun.exe**.

3.

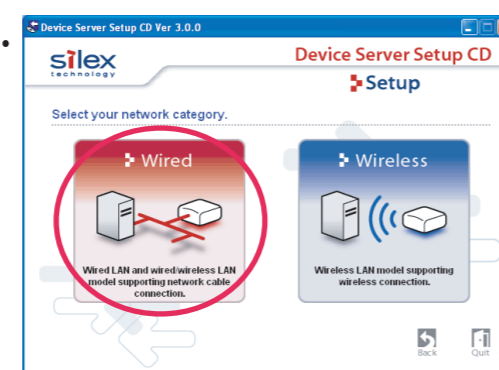

Please select **Wired**.

\* Select the network connection type.

Click **Wired** for a wired network. This Setup Guide explains how to configure with a wired network.

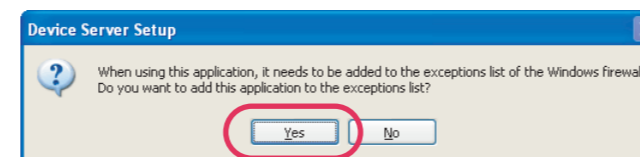

\* When in a Windows XP environment (SP2 or higher), this message will be displayed. Select **Yes**.

\* The User Account Control screen is displayed when configuration is performed on Windows Vista. Select **Continue**.

4.



Click **Next**.

5.

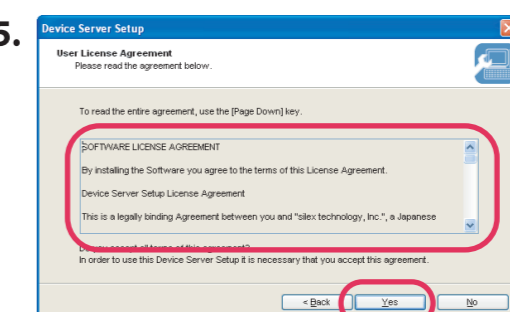

Read the agreement and click **Yes** to accept.

6.

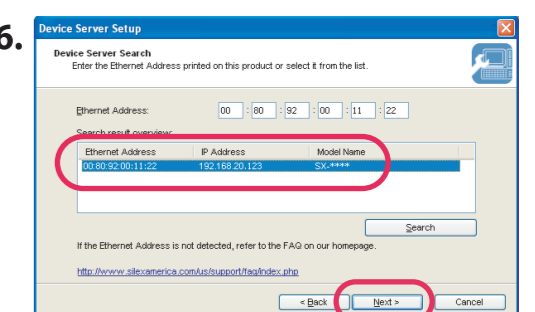

Select this product and click **Next**.

\* When this product is not found in the list, please confirm that the IP address of PC is configured correctly.

\* If you use security or firewall software, including those embedded in Windows XP, please temporarily disable them.

7.

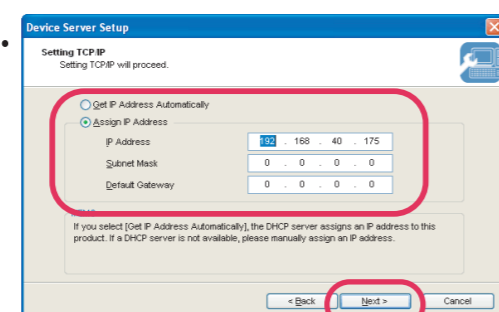

Enter an IP address for this product and click **Next**.

\* When using DHCP/BOOTP server etc. please click **Get IP Address Automatically**.

8.

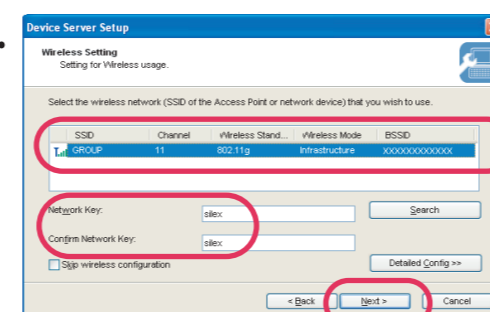

When you will use SX-2000WG in the wireless LAN, select the wireless network that you wish to use from the list, enter the wireless network key and click **Next**.

\* Enter the wireless configuration information prepared in advance. If the wireless network that you wish to use is not shown in the list, click **Detailed Config** and configure each setting. For **Detailed Config**, please refer to the online manual. If you are going to use SX-2000WG with a network cable instead of wirelessly, check **Skip wireless configuration** and click **Next**.

9.

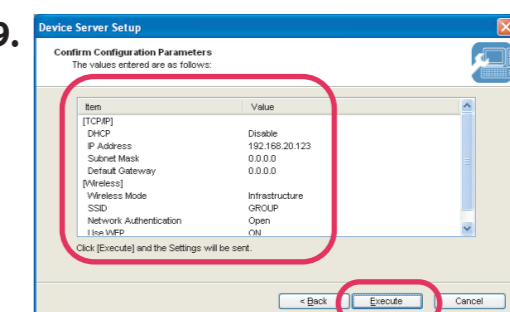

Please confirm the configuration parameters and click **Execute**.

10.

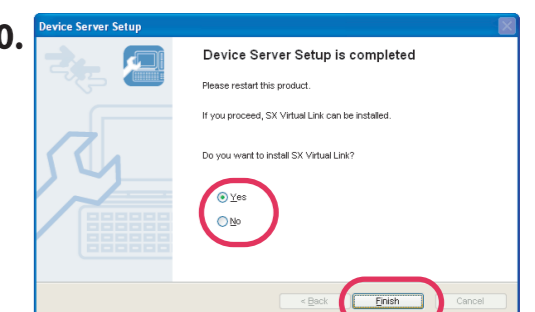

Select **Yes** and click **Finish**.

Go on to install the USB device connection utility, SX Virtual Link. Please refer to the "SX Virtual Link User's Guide".

## Macintosh section

1. Please insert the **Device Server Setup CD** into your
2. In a Macintosh environment, double click the CD-ROM icon and then double click **DSSetup**.

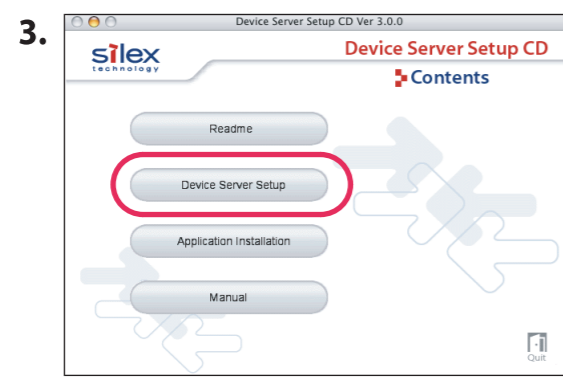

Please select **Device Server Setup** from the menu.



Please select **Wired**.

\* Select the network connection type. Click **Wired** for a wired network. This Setup Guide explains how to configure with a wired network.



Click **Next**.



Read the agreement and click **Yes** to accept.

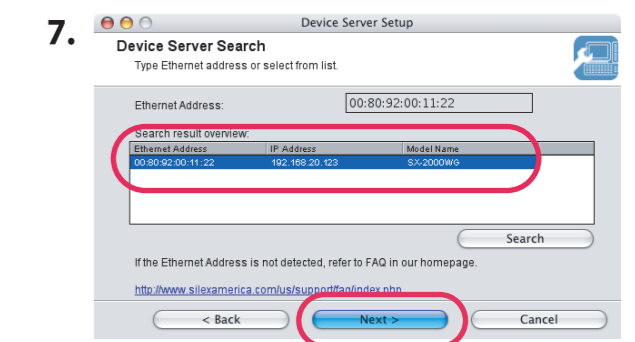

Select this product and click **Next**.

\* When this product is not found in the list, please confirm that the IP address of PC is configured correctly.



Enter an IP address for this product and click **Next**.

\* When using DHCP/BOOTP server etc. please click **Get IP Address Automatically**.



When you will use SX-2000WG in the wireless LAN, select the wireless network that you wish to use from the list, enter the wireless network key and click **Next**.

\* Enter the wireless configuration information prepared in advance. If the wireless network that you wish to use is not shown in the list, click **Detailed Config** and configure each setting. For **Detailed Config**, please refer to the online manual. If you are going to use SX-2000WG with a network cable instead of wirelessly, check **Skip wireless configuration** and click **Next**.

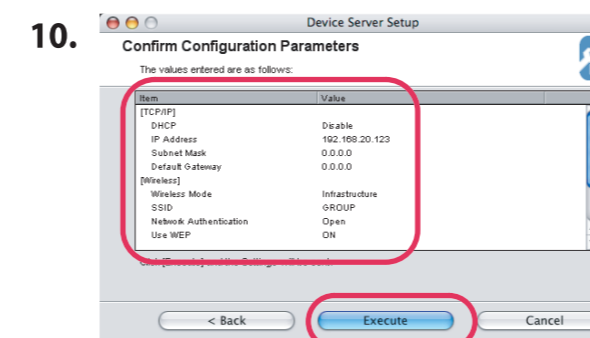

Please confirm the configuration parameters and click **Execute**.

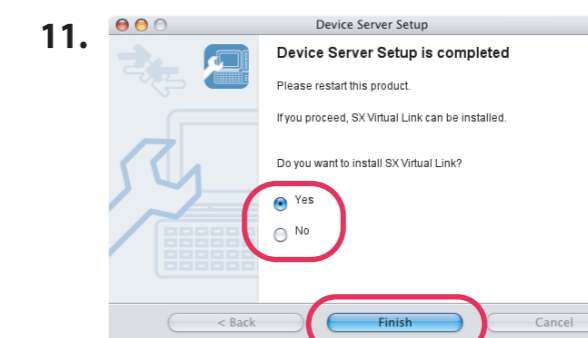

Select **Yes** and click **Finish**.

12. Go on to install the USB device connection utility, SX Virtual Link. Please refer to the "SX Virtual Link User's Guide".

## Step3 Enable the settings

Restart this product for the new settings to take effect.

1. To reflect the wireless configuration, disconnect the power plug from the outlet and unplug the network cable. Do not unplug the network cable when using this product with a wired LAN.

2. Connect the USB devices to be shared over the network along with this product via a USB cable2.

3. Insert the power plug into the outlet. The initial configuration of this product is complete.

## Refer to online manual

The CD-ROM contains the online manual of this product. Detailed information on the configuration, use of this product and Q&A for tips for trouble is described in the online manual. The following is the procedure on how to refer to the online manual.

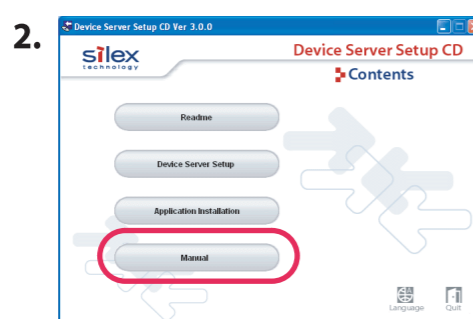

Click **Manual**.

\* If the screen does not appear automatically, open My Computer, select the CD-ROM drive and execute **Autorun.exe**.



Click **SX-2000WG**.

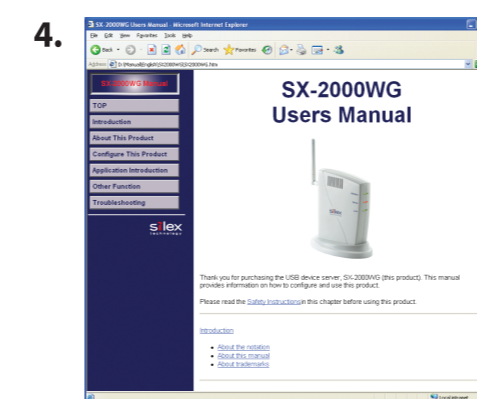

Online manual will be displayed.

## Windows section

1. Please insert the **Device Server Setup CD** into your PC.

1. Please insert the **Device Server Setup CD** into your PC.

2. In a Macintosh environment, double click the CD-ROM icon and then double click **DSSetup**.

## Macintosh section



Click **Manual**.



Click **SX-2000WG**.



Online manual will be displayed.

## User Registration

After completing the configuration for this product, please complete the user registration on our home page. User registration is highly recommended to assure you better support for your product.

For user registration, please visit our web site at

<http://www.silex.jp/register/>

\* For user registration, a "Serial Number" is required. The serial number is the last 6 digits of the alphanumeric characters listed on the back side of the product.

For example, if "008092001122" is listed, the serial number is "001122".

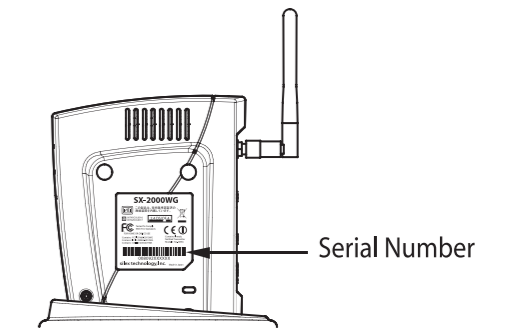

## Reset to the factory default settings

Remove the AC plug from the electric outlet.

Push and hold the push switch while re-inserting the AC plug into the electric outlet. Continue holding.

The Status LED(Orange) will light when the factory default configuration settings have been restored. Release the push switch.

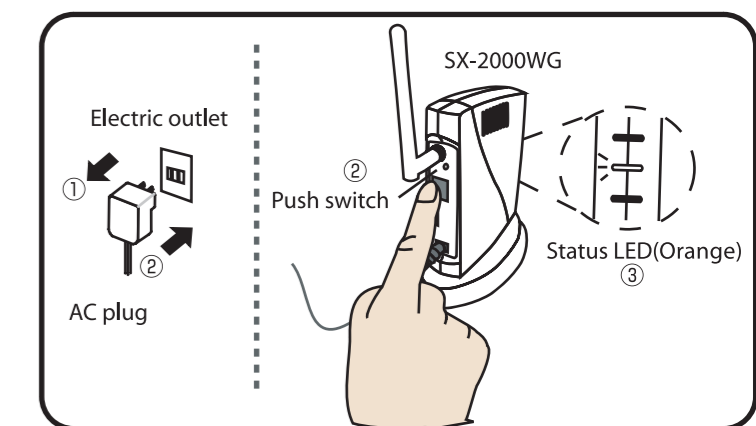

## Troubleshooting

Please refer to the following procedure if you have any problems regarding the setup.

1 Refer to the Q&A in the online manual. (See the instructions on the left.)

2 Refer to the FAQ in our homepage

3 Contact our customer support center

### Customer Support

**USA : SILEX TECHNOLOGY America, Inc.**  
E-mail : support@silexamerica.com  
URL : <http://www.silexamerica.com/>  
Phone : 1-866-765-8761

**Europe : SILEX TECHNOLOGY Europe GmbH**  
E-mail : support@silexeurope.com  
URL : <http://www.silexeurope.com/>  
Phone : +49(0)21596750-0